

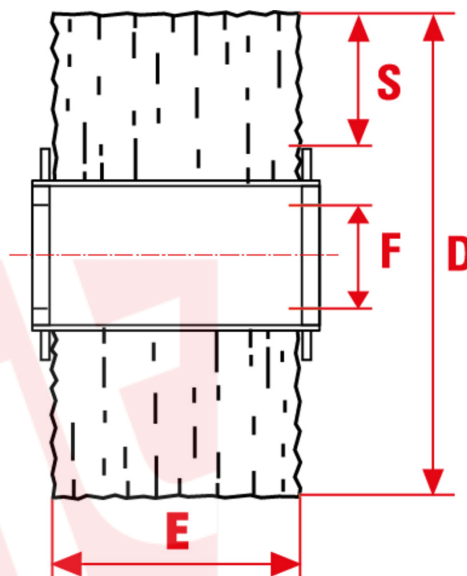

1375



Roller brushes for Flex brush machines and satin finishing machines, available in a variety of materials. They may be fitted on angle grinders (with speed regulation) or drills by using the appropriate adapter shafts.

TYPE OF USE

Suitable for a variety of processes (satin finishing, sanding, ageing) on iron, stone, marble and wood.

	MM
D mm	110
E mm	100
Hole mm	19+2ch
Max RPM	5700
CO/IS pack	1 /6
Art.	RSFP - FLEX
Filament	Abrasive Nylon
Ø Filament	1,50mm
Grit	

	INCH
D inch	4-3/8
E inch	4
Hole inch	3/4+2ch
Max RPM	5700
CO/IS pack	1 /6
Art.	RSFP - FLEX
Filament	Abrasive Nylon
Ø Filament	0,059"
Grit	

Le dimensioni, le illustrazioni, le caratteristiche tecniche, le referenze e tutti gli altri dati contenuti nel catalogo possono essere modificati da SIT senza preavviso. Tutte le dimensioni riportate sul catalogo sono da considerarsi nominali e, se non diversamente specificato, sono in mm. Diametri, sporgenze e spessori degli insiemi di filamenti, costituenti le spazzole, sono da considerare tali solo approssimativamente.
The dimensions, illustrations, technical characteristics and all other data contained in the catalogue may be changed by SIT without prior notice. All dimensions on the catalogue, unless otherwise specified, are in mm. Diameters, protrusions and thicknesses of sets of filaments forming the brushes are only approximate.

SIT Società Italiana TecnoSpazzole S.p.A

C.F. e Reg. Imprese 03492470376
Via Porrettana, 453
40033 - Casalecchio di Reno (Bo)
ITALY

Partita I.V.A./VAT IT00626581201
Codice SDI: A4707H7
Import/Export BO 008277
R.E.A. BO 295504

Tel. +39 0516113211
Fax +39 051574319
PEC: sit_tecnospazzole@legalmail.it
info@sitbrush.com

INDUSTRIAL BRUSHES MANUFACTURER
WITH QUALITY MANAGEMENT SYSTEM
CERTIFIED ISO 9001

sitbrush.com