

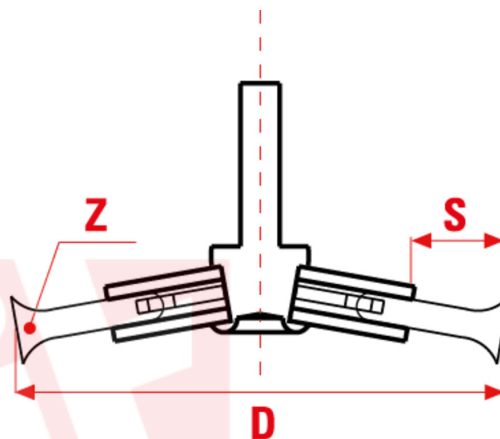

0312



**Z = n° mazzetti / number of knots
n° de mèches torsadées**

The conical shape makes these brushes suitable for sideways jobs on irregular surfaces, with edges, profiles and cracks. The twisted knots make them aggressive.

TYPE OF USE

To remove slags, rust and residues from surfaces of any shape and material.

sitbrush.com

MM		INCH	
D mm	95	D inch	3-3/4
S mm	20	S inch	3/4
Z n°	18	Z n°	3/4
Hole mm	M10	Hole inch	M10
Max RPM	14000	Max RPM	14000
CO/IS pach	1 /36	CO/IS pack	1 /36
Art.	CZ95	Art.	CZ95
Filament	Steel	Filament	Steel
Ø Filament	0,50mm	Ø Filament	0,020"

Le dimensioni, le illustrazioni, le caratteristiche tecniche, le referenze e tutti gli altri dati contenuti nel catalogo possono essere modificati da SIT senza preavviso. Tutte le dimensioni riportate sul catalogo sono da considerarsi nominali e, se non diversamente specificato, sono in mm. Diametri, sporgenze e spessori degli insiemi di filamenti, costituenti le spazzole, sono da considerare tali solo approssimativamente.
The dimensions, illustrations, technical characteristics and all other data contained in the catalogue may be changed by SIT without prior notice. All dimensions on the catalogue, unless otherwise specified, are in mm. Diameters, protrusions and thicknesses of sets of filaments forming the brushes are only approximate.

SIT Società Italiana TecnoSpazzole S.p.A

C.F. e Reg. Imprese 03492470376
Via Porrettana, 453
40033 - Casalecchio di Reno (Bo)
ITALY

Partita I.V.A./VAT IT00626581201
Codice SDI: A4707H7
Import/Export BO 008277
R.E.A. BO 295504

Tel. +39 0516113211
Fax +39 051574319
PEC: sit_tecnospazzole@legalmail.it
info@sitbrush.com

INDUSTRIAL BRUSHES MANUFACTURER
WITH QUALITY MANAGEMENT SYSTEM
CERTIFIED ISO 9001

sitbrush.com