

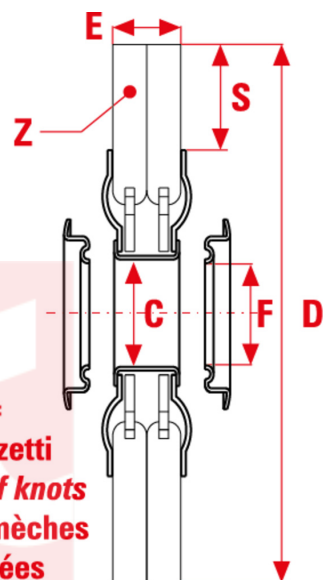

0531



Rundbürsten mit gedrehten Borstenbüscheln aus Stahldraht für schwere Arbeiten bei hoher Drehgeschwindigkeit.

ART DER NUTZUNG

Entgraten und aggressives mechanisches Beizen.

sitbrush.com

MM		INCH	
C mm	77	C inch	3
D mm	250	D inch	10
E mm	30	E inch	1-1/8
S mm	48	S inch	1-7/8
Z n°	40X2	Z n°	1-7/8
Loch mm	25	Loch inch	1
Max RPM	4500	Max RPM	4500
CO/IS pach	1	CO/IS pack	1
Art.	U8252	Art.	U8252
Gewinde	Stahl	Gewinde	Stahl
Ø Gewinde	0,80mm	Ø Gewinde	0,031"

Le dimensioni, le illustrazioni, le caratteristiche tecniche, le referenze e tutti gli altri dati contenuti nel catalogo possono essere modificati da SIT senza preavviso. Tutte le dimensioni riportate sul catalogo sono da considerarsi nominali e, se non diversamente specificato, sono in mm. Diametri, sporgenze e spessori degli insiemi di filamenti, costituenti le spazzole, sono da considerare tali solo approssimativamente.
 The dimensions, illustrations, technical characteristics and all other data contained in the catalogue may be changed by SIT without prior notice. All dimensions on the catalogue, unless otherwise specified, are in mm. Diameters, protrusions and thicknesses of sets of filaments forming the brushes are only approximate.

SIT Società Italiana TecnoSpazzole S.p.A

C.F. e Reg. Imprese 03492470376
 Via Porrettana, 453
 40033 - Casalecchio di Reno (Bo)
 ITALY

Partita I.V.A./VAT IT00626581201
 Codice SDI: A4707H7
 Import/Export BO 008277
 R.E.A. BO 295504

Tel. +39 0516113211
 Fax +39 051574319
 PEC: sit_tecnoSpazzole@legalmail.it
 info@sitbrush.com

INDUSTRIAL BRUSHES MANUFACTURER
 WITH QUALITY MANAGEMENT SYSTEM
 CERTIFIED ISO 9001

sitbrush.com